

SCHEDA TECNICA  
DATA SHEET

# Boston

COFFEE TABLE

 **KICO**  
THE HOME. MADE IN ITALY.



## FINITURE DISPONIBILI | AVAILABLE FINISHES

### FINITURE TAVOLINO LOW TABLE FINISHES

METALLO | METAL

**MET.102** LACCATO CACAO | CACAO LACQUARED

**MET.103** LACCATO GRIGIO TECA | GRIGIO TECA LACQUARED

**EB** ESSENZA BASE | BASIC VENEERED

**EP** ESSENZA PLUS | PLUS VENEERED

### FINITURE TOP TOP FINISHES

VETRO | GLASS

**VET** VETRO CAT A | A CAT GLAS

- Trasparente bronzo | Bronze transparent glass

- Trasparente grigio | Grey transparent glass

**VET** VETRO CAT C | C CAT GLAS

- Specchio bronzo | Bronze mirror

- Specchio dark | Dark mirror

**GRSA** GRES CATEGORIA A | A CAT.GRES

**GRSB** GRES CATEGORIA B | B CAT. GRES

## MODULARITÀ | MODULARITY

BOSTON 01

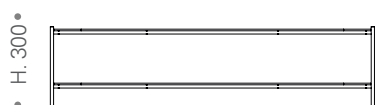

H. 300

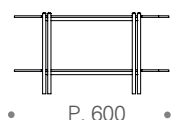

P. 600



L. 1200

BOSTON 02

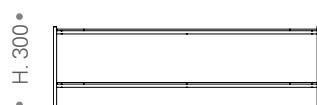

H. 300

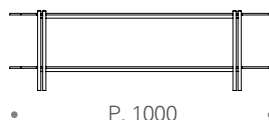

P. 1000

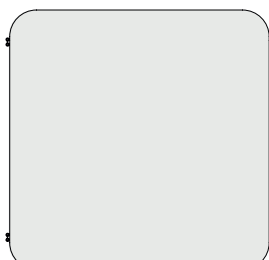

L. 1000

BOSTON 03

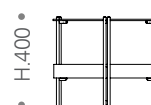

H. 400

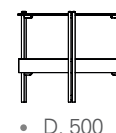

D. 500

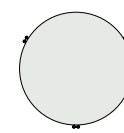

D. 500

## CARATTERISTICHE TECNICHE | TECHNICAL CHARACTERISTICS

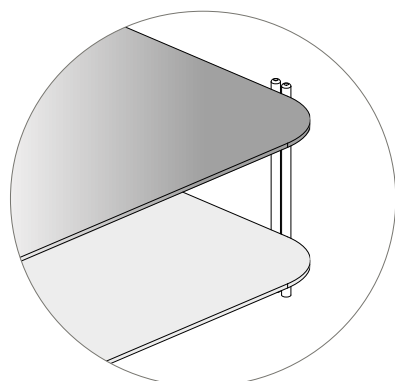

### GESTIONE DEI PIANI | TOPS MANAGEMENT

Il doppio piano di appoggio, con cui è caratterizzata la collezione dei coffee tables Boston, viene gestito sempre con finitura differente, la scelta assicura una ricercata coerenza stilistica. Il piano superiore deve essere sempre scelto in Vetro Trasparente Bronzo o Vetro Trasparente Grigio, e lo spessore sarà di 4 mm. Mentre la scelta del piano inferiore è sempre libera e, scegliendo il Gres Ceramico lo spessore sarà di 6 mm.

*The double top, with which the collection of Boston coffee tables is characterized, is always managed with different finish, the choice ensures a refined stylistic consistency. The upper top must always be chosen in Transparent Bronze Glass or Transparent Gray Glass, and the thickness will be 4 mm. While the choice of the lower top is always free, and by choosing Ceramic Stoneware the thickness will be 6 mm.*

## KICO SRL

Via dell'industria 64032  
Casoli di Atri - Teramo - ITALY

TEL +39 085.94 63 052

TEL +39 085.94 63 405

EMAIL [info@kico.it](mailto:info@kico.it)

FAX +39 085.79 92 060

[www.kico.it](http://www.kico.it)

Follow us on Instagram, Facebook,  
Linkedin and Pinterest